

Item Code and Description

- a. 21045
- b. 59" × 47¼" TrueDEK Classic shower former

General Product Description

- a. prefabricated, tileable, structural, pre-sloped shower receptor
- b. cover with decorative tile, stone, or weldable resilient flooring

Physical Characteristics

- a. made of fiberglass reinforced plastic (GRP)
- b. spans 16" o.c. joist systems
- c. edges are 7/8" thick
- d. drain hole diameter is 6¼"
- e. four gradient planes
- f. gradients are 2% per foot or greater—varies due to length of pitch
- g. off-center drain hole
- h. underside of foundation is ribbed for strength while reducing weight
- i. perimeter has 1¾"-wide leveling rim with pre-bored, countersunk pilot holes
- j. color: blue
- k. weight: approximately 70 lbs.
- l. made from 100% recyclable materials

Performance Characteristics

- a. pre-pitched foundation for shower construction
- b. install on wood or engineered joist systems, on subfloor, or on concrete
- c. rotate foundation to avoid conflicts between drain and obstructions
- d. cut and drill as needed with standard power tools
- e. may be trimmed on all sides (remain at least 6" from drain hole)
- f. rated to carry a 840 lb. load when installed on proper joists spaced 16" o.c. supplemented with perimeter and drain hole blocking (increase load capacity with additional blocking and support)
- g. complete installation requires a Classic Drain Assembly and waterproofing materials
- h. remove tile, redo waterproofing, and re-tile without damaging foundation

Compliance

- a. ICC PMG-1223 lists compliance with:
 1. 2015, 2012 and 2009 International Residential Code® (IRC)
 2. 2015, 2012 and 2009 International Plumbing Code® (IPC)
 3. 2015, 2012 and 2009 Uniform Plumbing Code® (UPC)
 4. 2010 and 2005 National Plumbing Code of Canada (NPC)
 5. IAPMO PS106-2015e1 for prefabricated, tileable shower receptors
 6. CSA B45.5/IAPMO Z124-2011, Plastic Plumbing Fixtures
- b. QAI Laboratories test report no. RJ4241-1
 1. meets conditions of classification for 30-minute flame spread index and smoke developed index per ASTM E84 requirements



Other Information

- a. AKW limited lifetime warranty

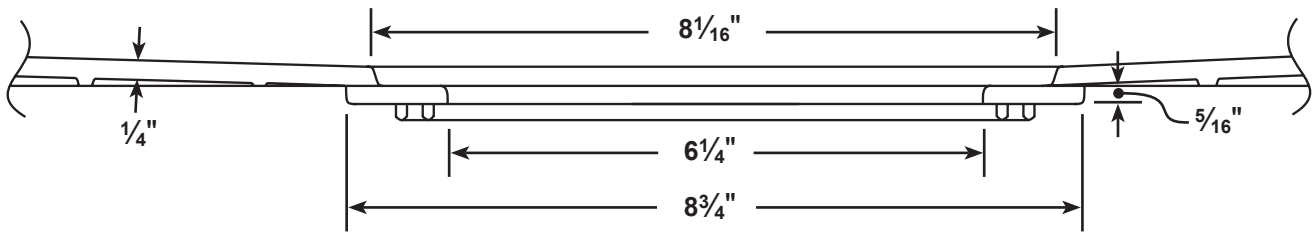
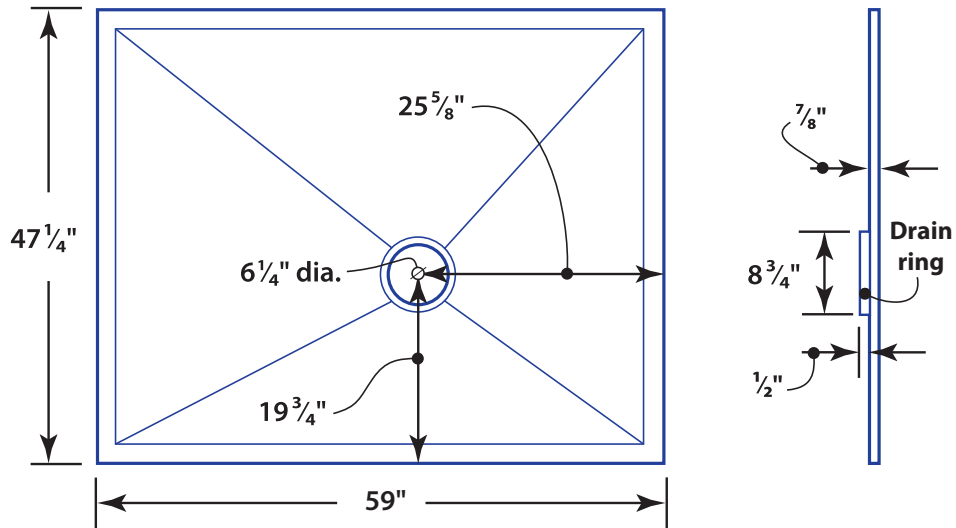

Drain hole cutaway view

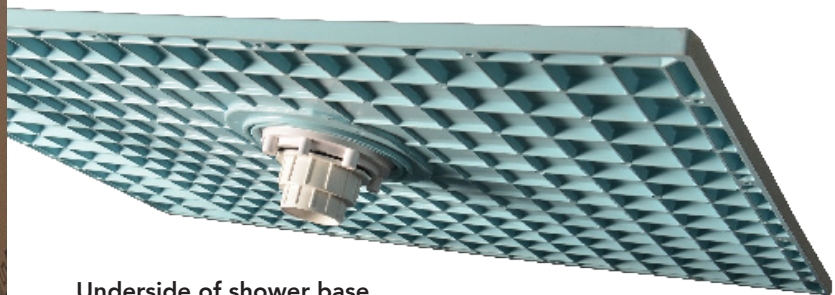

Underside of shower base showing structural ribbing and drain hole reinforcement ring (drain installed).

Classic shower base installed on joists.